

Main window

Introduction

The following is a description of the main window – its structure and the different areas.

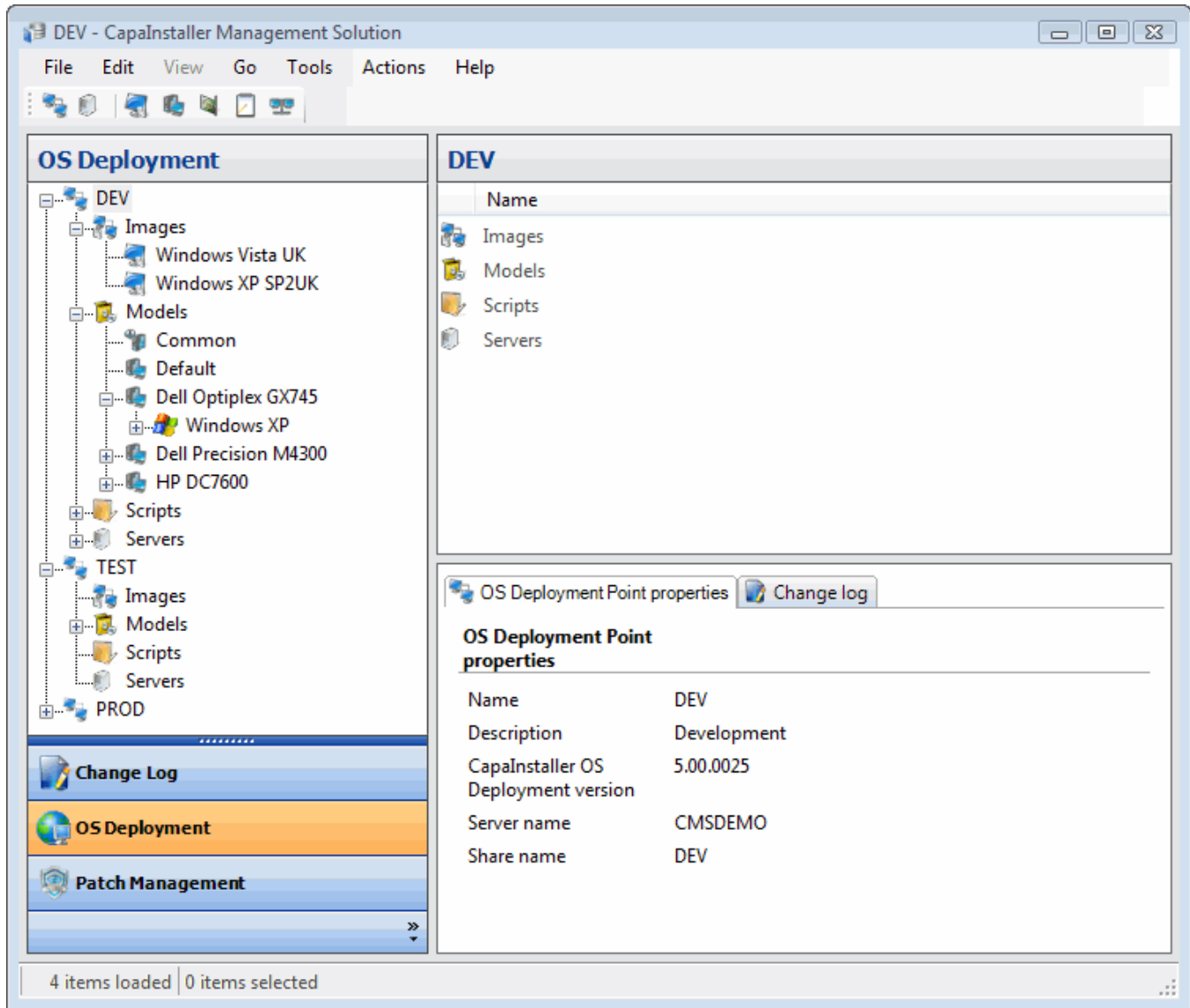

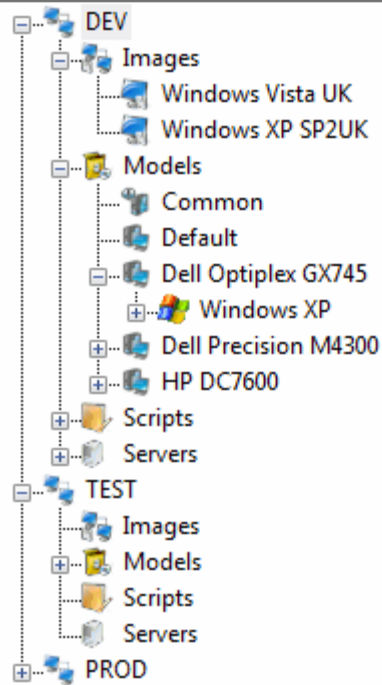

Element	Description
	Menu bar.
	Toolbar. Each plugin has its own toolbar.

OS Deployment



 **Change Log**

 **OS Deployment**

 **Patch Management**



Navigation pane.

Top most:





The top most part of the navigation pane typically shows a treeview. Each plugin will have its own treeview with nodes that represent entities available for that particular plugin.

Bottom most:

Outlook like navigation that is used to switch between plugins. It is possible to rearrange the order, minimize certain buttons and also to hide unwanted buttons.



DEV

Name

-  Images
-  Models
-  Scripts
-  Servers

Content pane. This pane will change view depending on the selected item in the navigation pane.

[Detail view](#)

 OS Deployment Point properties  Change log

OS Deployment Point properties

Name	DEV
Description	Development
CapaInstaller OS Deployment version	5.00.0025
Server name	CMSDEMO
Share name	DEV

4 items loaded | 0 items selected

Status strip. Some plugins will be using this part of the user interface to display various types of information.